

OPT 2-JAW HIGH SPEED HOLLOW POWER CHUCKS

二爪高速中空油壓夾頭

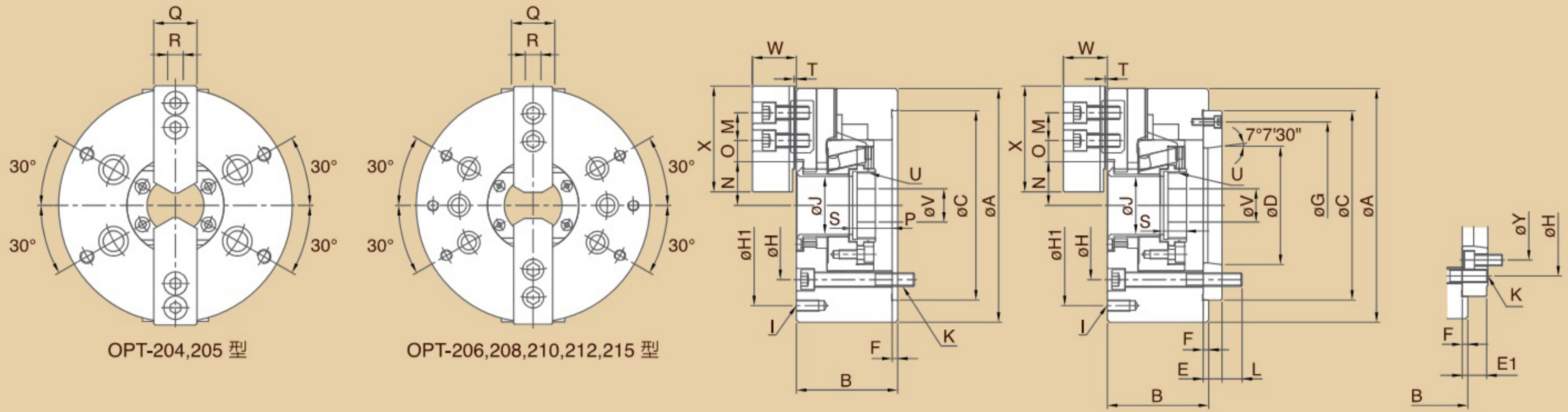

尺寸圖 » Dimensions



規格表 » Specifications

單位/UNIT:mm

型式/規格 MODEL /SPEC.	主軸鼻端番號 Nose Of Spindle	A	B	C (h6)	D	E	E1	F	G	H	H1	I	J	K	L
OPT-204	--	110	59	85	--	--	--	4	--	70.6	--	--	26	4-M10x1.5P	--
OPT-205	A ₂ -4	135	60	110	63.513	20	--	4	96	82.6	PCDø118	4-M8x1.25P	33	4-M10x1.5P	15
OPT-206	A ₂ -5	169	81	140	82.563	15	--	5	116	104.8	PCDø145	6-M10x1.5P	45	6-M10x1.5P	16
OPT-208	A ₂ -6(A ₂ -5)	210	91	170	106.375	17	23	5	150	133.4	PCDø180	6-M10x1.5P	52	6-M12x1.75P	18
OPT-210	A ₂ -8(A ₂ -6)	254	100	220	139.719	18	28	5	190	171.4	PCDø225	6-M12x1.75P	75	6-M16x2P	19
OPT-212	A ₂ -8	304	110	220	139.719	18	--	6	190	171.4	PCDø250	6-M12x1.75P	91	6-M16x2P	25
OPT-215	A ₂ -11(A ₂ -8)	381	133	300	196.869	22	33	6	260	235	PCDø324	6-M12x1.75P	117.5	6-M20x2.5P	28

型式/規格 MODEL /SPEC.	M	N max.	N min.	O max.	O min.	P max.	P min.	Q	R	S	T	U	V	W	X	Y	通孔直徑 Thru-Hole [Diameter] (mm)	柱塞行程 Plunger Stroke (mm)
OPT-204	14	23	20.3	11.5	6.7	3.5	-6.5	23	10	17.5	2	M32x1.5P	12	24	49.5	--	26	10
OPT-205	14	26.2	23.5	19	6	1	-9	25	10	20	2	M40x1.5P	12	31.5	62	--	33	10
OPT-206	20	32.35	29.6	24	7	11	-1	31	12	19	2	M55x2P	20	37.5	73	--	45	12
OPT-208	25	39.1	35.4	30	10	14.5	-1.5	35	14	20.5	2	M60x2P	30	39.5	95	104.8	52	16
OPT-210	30	51.5	47.1	34	12	8.5	-10.5	40	16	25	2	M85x2P	40	43	110	133.4	75	19
OPT-212	30	61.6	56.3	46	12	8	-15	50	21	28	2	M100x2P	50	51	129	--	91	23
OPT-215	43	82.3	77	46	13	7.5	-16	62	22	42.5	5	M130x2P	48	66.5	165	171.4	117.5	23

型式/規格 MODEL /SPEC.	爪行程 〔直徑〕 Jaw Stroke [Diameter] (mm)	最高迴轉速 Max.Speed r.p.m.(min ⁻¹)	最大拉力 Max. Pull Force kgf (KN)	最大靜夾持力 Max. Gripping Force kgf (KN)	最大設定 油壓壓力 Max. Hydr. Pressure kgf/cm ² (Mpa)	淨重 Weight (kg)	搭配 油壓缸型號 Matching Cylinder	夾持範圍 Gripping Range
OPT-204	5.4	8000	920 (9)	1930 (19)	15.5 (1.5)	3.6	P0928	ø7~ø110
OPT-205	5.4	7000	1120 (11)	2340 (23)	19 (1.9)	6.5	P1036	ø10~ø135
OPT-206	5.5	6000	1420 (14)	3770 (37)	18.5 (1.8)	13.1	P1246	ø13~ø169
OPT-208	7.4	5000	2240 (22)	5710 (56)	17 (1.7)	23.0	P1552	ø13~ø210
OPT-210	8.8	4200	2850 (28)	7440 (73)	18 (1.8)	35.9	P1875	ø30~ø254
OPT-212	10.6	3300	3670 (36)	9690 (95)	18 (1.8)	56.6	P2091	ø35~ø304
OPT-215	10.6	2500	4790 (47)	12130 (119)	17 (1.7)	103.2	P2511	ø35~ø381